



HEAT & GLO™

No one builds a better fire



SlimLine® Series
Gas Fireplaces



A



B

Less space
& more options



C

Cover: SL-350TRS shown with Kenwood corner cabinet, optional raised hearth base, absolute black granite and Halston operable doors in graphite

A. SL-550TRS shown with Kenwood wall cabinet, optional raised hearth base, marron brown marble and Halston operable doors in new bronze

B. SL-750TR shown with Laurent mantel and hearth and Aero front in new bronze

C. SL-950TR shown with Kenwood mantel, New Venitian Gold granite and Chateau Deluxe front in graphite

The SlimLine Series—fireplaces that take up little space but give you lots of options, and a lot for your money. They're all about value, size and heat options.

Value because the Series is the best in its class, while remaining absolutely affordable.

Space because the shallow 16-1/4" depth goes practically anywhere. And four different widths provide an option for rooms cozy to great.

Heat Options because the Series offers models with varying heat outputs for different needs.



SL-550TR shown with Kenwood mantel, wheatfield granite and Clean Face Kit

SlimLine[®] Series

Value, Space and Heat Options

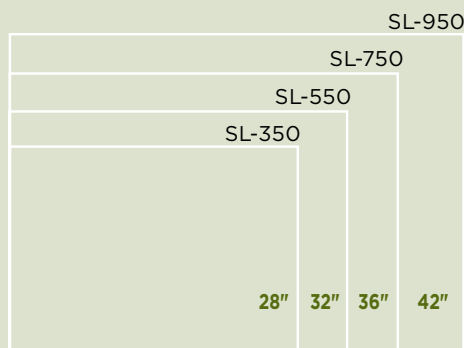

With so many options, you've got some choices to make: the width, model, front and mantel system.

Determine the width.

Choose from four widths—28", 32", 36" and 42". The right size for the wall and room is important. A fireplace that's too small looks disproportionate. A fireplace that's too big can overheat the room. Your salesperson can help you determine the best fit.



Choose a model.

TRS models: Offer the Series' best flame, with an advanced ceramic burner and refractory, plus richly detailed logs. They generate the most heat and are AFUE rated for high efficiency.

TR models: Provide a full flame and realistic log set. They generate a moderate level of heat.

Options, options
& more options



Select a front.

Choose from three fronts—each available in black, graphite and new bronze

Aero Front

INSIDE FIT



Chateau Deluxe Front

OVERLAP FIT



Halston Operable Doors

OVERLAP FIT



FINISHES

Choose from three beautiful finishes



Black



Graphite

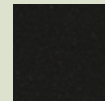

New Bronze

Chateau Deluxe Front and Halston Operable Doors completely overlap surround materials for a clean look. Adjustable hinges allow for variations in the thickness of surround materials of up to 1".

Chateau Deluxe Front for SL-350 Model



CLEAN FACE KIT

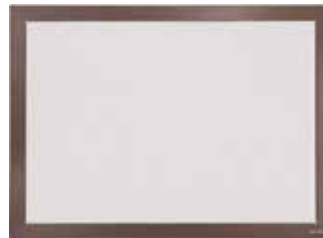

Works with SL-550TR and SL-750TR and comes with its own front.

Allows surround materials like brick, stone and tile to come flush to the firebox edge for a cleaner finish.

Pick a mantel system.

Whether your style is traditional, transitional or modern, finishing your fireplace couldn't get any easier.



Kenwood flush mantel
Shown with SL-550TR



Kenwood flush mantel with optional raised hearth base Shown with SL-750TRS



Kenwood wall or corner cabinet with optional raised hearth base (not available on 950 models) Shown with SL-350TRS



Laurent cast mantel and hearth (not available on 350 models) Shown with SL-750TR

THE KENWOOD

Available three ways—flush mantel, wall cabinet or corner cabinet. Add a raised hearth base to any option. Available in primed wood, ready to be painted.

THE LAURENT

Its graceful shape and matching curved hearth are formed from a cast material, ready to be painted.

MANTEL OPTIONS - shown unfinished

Featuring mantels and surrounds by Fireside Furnishings, the Slimline series has a broad selection of wood and cast hearth design solutions available to finish around and showcase the beautiful fire.

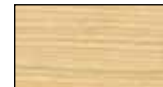

Oak



Maple



MDF Primed

NATURAL STONE OPTIONS

Complete your hearth system with a variety of natural stone options from our Select, Signature or Designer Series of surrounds.

Select Series



Wheatfield Granite

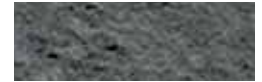

Slate

Signature Series



Tan Brown Granite



New Venetian Gold Granite



Caledonia Granite



Green Granite



Absolute Black Granite

Designer Series



Beige Marble



Marron Brown Marble

Modern Collection Surrounds for SL-550TR and SL-750TR

Use with Aero front only



Echo with SL-550TR



Luna with SL-750TR

Mantels for SL-750 Models only



Portico in painted maple



Sonoma in knotty alder



Parsons in chocolate alder

Actual product appearance, including flame, may differ from product images.

SlimLine Mantels and Cabinets

Kenwood Flush Mantel and Optional Raised Hearth Base

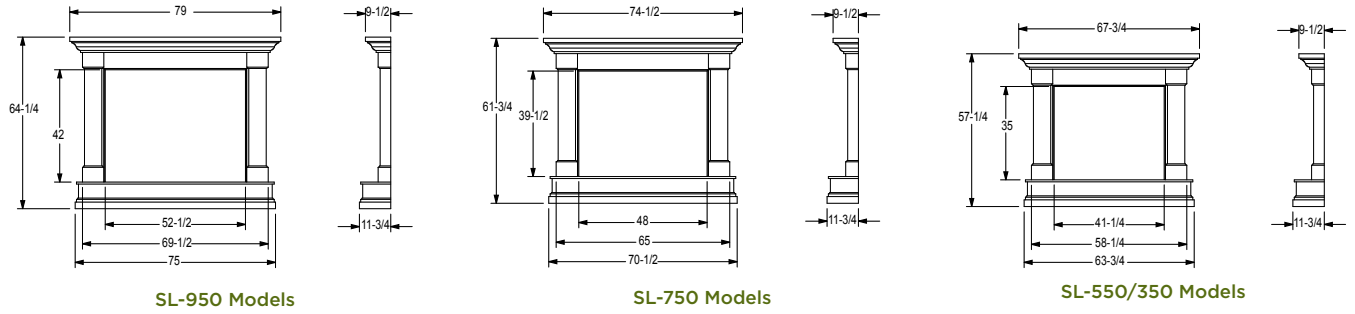

Kenwood Flush Cabinet and Optional Raised Hearth Base

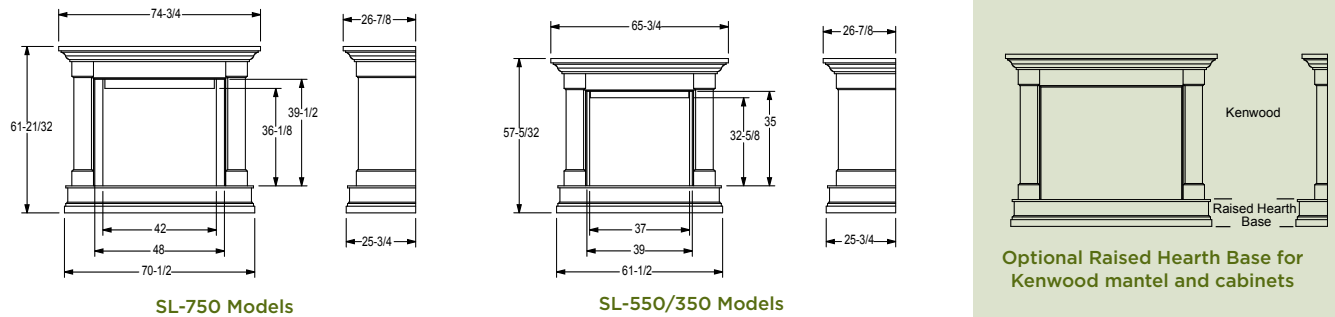

Kenwood Corner Cabinet and Optional Raised Hearth Base

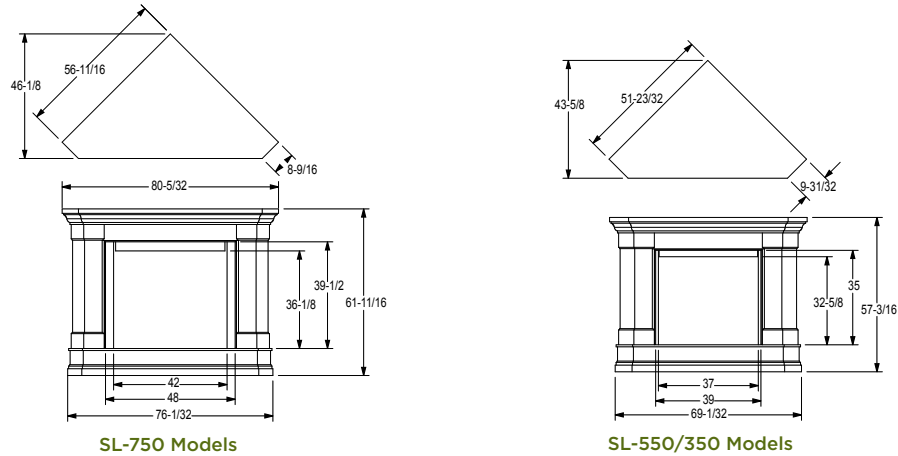

Laurent Cast Surround

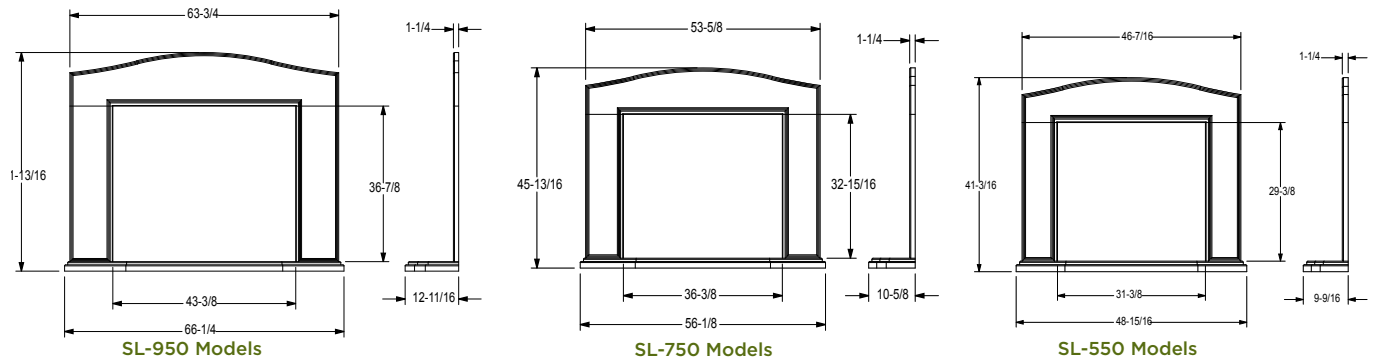

SlimLine Specifications

MODEL	FRONT WIDTH		BACK WIDTH		HEIGHT		DEPTH		VIEWING AREA	BTU/HOUR INPUT (NG)
	Unit	Framing	Unit	Framing	Unit	Framing	Unit	Framing		
SL-350TRS	33	34	22-3/4	34	32-3/8	32-3/4	16-1/4	16-1/4	27-1/2 x 19	14,400-20,500
SL-550TR & TRS	36	37	25-3/4	37	34-3/8	34-3/4	16-1/4	16-1/4	30-1/2 x 21	18,200-27,300 (TRS) 15,000-21,000 (TR)
SL-750TR & TRS	40-7/8	42	30-3/4	42	37-7/8	38-1/4	16-1/4	16-1/4	35 x 24-1/2	20,200-30,800 (TRS) 16,900-24,300 (TR)
SL-950TR	48	49	37-3/4	49	41-7/8	42-1/4	16-1/4	16-1/4	43 x 22	20,900-30,400

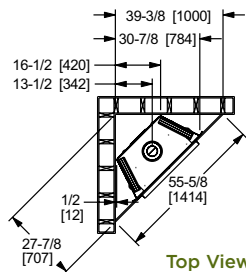

Top View Corner Installation

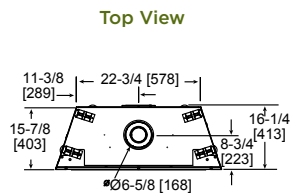

Top View

SL-350TRS
Side View

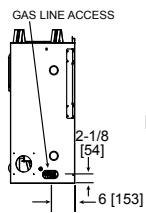

Front View

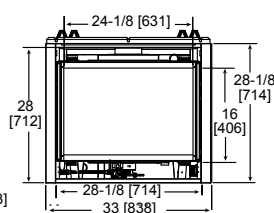

Side View

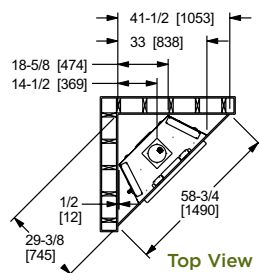
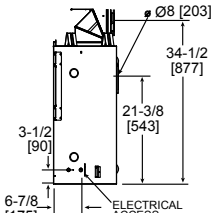

Top View Corner Installation

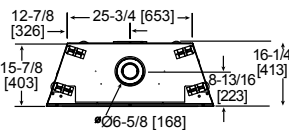

Top View

SL-550TR & TRS
Side View

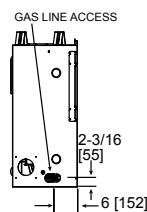

Front View

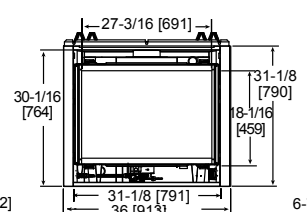

Side View

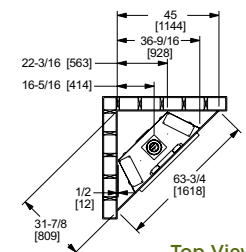
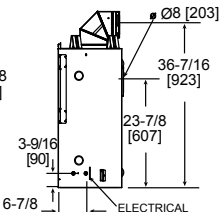

Top View Corner Installation

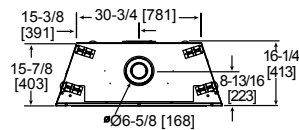

Top View

SL-750TR & TRS
Side View

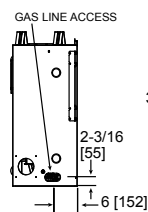

Front View

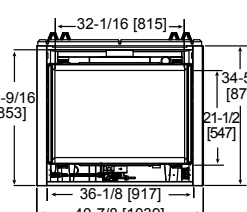

Side View

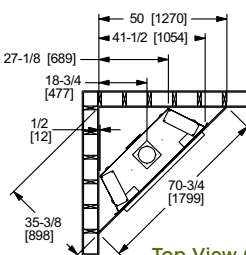
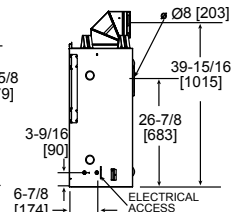

Top View Corner Installation

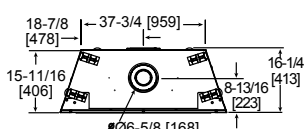

Top View

SL-950TR
Side View

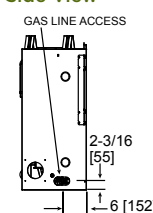

Front View

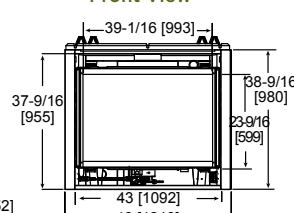

Side View

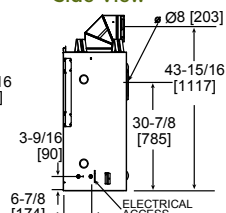

Dimensions above are in inches and millimeters. Product information is not complete and is subject to change without notice. Product installation must adhere strictly to instructions shipped with product. We recommend measuring individual units at installation. Assumes the use of 1/2" sheetrock. NOTE: Combustible material should not cover the face. Make sure you do NOT cover the decorative door opening.

Refer to installation manual for detailed specifications on installing this product. Heat & Glo reserves the right to update units periodically. The flame and ember appearance may vary based on the type of fuel burned and the venting configuration used. Actual product appearance, including flame, may differ from product images.

Healthy Hearth

Our direct vent fireplaces will not alter the quality of indoor room air in any way. They utilize a sealed combustion chamber that draws in fresh air from outdoors and discards all combustion by-products back outside.

IntelliFire™

Our exclusive, state-of-the-art, "green friendly" IntelliFire ignition system reduces gas consumption and thermogenerator wear by providing a pilot flame only when needed. It also supplies a back-up battery system to run the fireplace during a power outage.

SlimLine Model Comparison

MODEL	TECHNOLOGY	VIEWING WIDTH	SETTING
SL-350	TRS	28"	Ideal for corners or between windows
SL-550	TRS or TR	32"	Sized perfectly for an owner's suite or den
SL-750	TRS or TR	36"	A great choice for a great room
SL-950	TR	42"	Designed to be proportional to larger rooms

SlimLine Model Features

FEATURES	SL-350TRS	SL-550TRS	SL-550TR	SL-750TRS	SL-750TR	SL-950TR
AFUE Rated	•	•		•		
Heater Rated			•		•	•
Brick Refractory Kit	optional	standard	optional	standard	optional	optional
Sealed Combustion Chamber	•	•	•	•	•	•
Selection of Decorative Fronts	•	•	•	•	•	•
Optional Fan Kit	•	•	•	•	•	•
Optional Remote Control/Wall Switch	•	•	•	•	•	•
Ceramic Gas Logs	4	5	5	5	5	5
Limited Lifetime Warranty	•	•	•	•	•	•
Top and Rear Direct Vent	•	•	•	•	•	•
IntelliFire™ Ignition System	•	•	•	•	•	•
Adjustable Valve	•	•	•	•	•	•
Gas Flex Connection	•	•	•	•	•	•
Ceramic Glass	•	•		•		
Tempered Glass			•		•	•

U.S. Efficiencies

Steady State - Since most homeowners use their fireplaces for an extended time while they are in the room, Steady State measures how efficiently your fireplace converts fuel to heat once it is warmed up and running in a "steady state".

AFUE - AFUE rating is more typically used with appliances, like your furnace, that continually cycle on and off to maintain a constant temperature.

Rating	SL-350TRS-IPI	SL-550TR-IPI-E	SL-550TRS-IPI-E	SL-750TR-IPI-E	SL-750TRS-IPI-E	SL-950TR-IPI-E
Steady State	77%	75%	75%	74%	78%	77%
AFUE	•		•		•	

Canada Efficiencies

EnerGuide (CSAP4.1-02) - EnerGuide is a rating used in Canada to measure annual fireplace efficiency.

Rating	SL-350TRS-IPI	SL-550TR-IPI-E	SL-550TRS-IPI-E	SL-750TR-IPI-E	SL-750TRS-IPI-E	SL-950TR-IPI-E
EnerGuide (CSAP4.1-02)	58%	51%	65%	56%	64%	61%

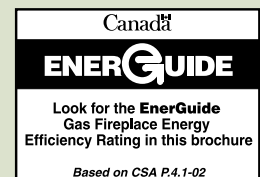

For complete information on this model, please contact us at:

HEAT & GLO

A brand of Hearth & Home Technologies Inc.®

7571 215th Street West, Lakeville, MN 55044
 Web: heatnglo.com
 Phone: (888) 427-3973 (952) 985-6000
 E-mail: info@heatnglo.com

For full warranty details, go to www.heatnglo.com.

Limited Lifetime Warranty*

The strongest in the industry, Heat & Glo provides a limited lifetime warranty on the most important aspects: firebox and heat exchanger.



HNG-1069U-0110